

PORCELANOSA® FACADES INSTALLATION MANUAL

TABLE OF CONTENTS

I. General recommendations.....	3
A. Structural requirements.....	3
B. Weather barrier/water penetration.....	3
C. Product inspection.....	3
D. Handling.....	3
E. Contact information for Tech. Dept.....	3
F. Profiles.....	3
G. Porcelain panels.....	4
H. Fasteners.....	4
I. Wall sections and elevation details.....	4
II. Safety.....	5
A. Dangers.....	5
B. First Aid.....	6
C. Storage.....	6
D. Disposal.....	6
E. Transport.....	6
F. Safe Handling.....	6
III. Recommended tools.....	7
IV. Installation.....	8
A. Preparing the substrate.....	8
B. Install substructure (omegas).....	9
C. Insulation install.....	11
D. Angle brackets.....	11
E. T and L profiles.....	12
F. Porcelain panels.....	12
1. Cutting panels, kerf cut instructions.....	12
a. Kerf saw cuts in porcelain tiles.....	13
2. Starter clip.....	13
3. Vertical and horizontal panel joints.....	13
4. p404 instructions.....	14
5. Rest of courses (end points).....	15
6. Termination.....	16
7. Doors and windows.....	17
8. Corners.....	18
a. Outside.....	18
b. Inside.....	18
c. Field mitered.....	19
d. Sloped grade/roof rake.....	19
9. Penetrations/signage.....	20
10. Soffit.....	20
V. Cleaning and maintenance.....	21
A. Initial cleaning of the facade.....	21
B. Regular cleaning.....	21
C. Cleaning paint residues or graffiti.....	21
D. Cleaning rust stains.....	21
E. Removal of dirt from rainwater.....	21
F. Cleaning the air chamber.....	21
VI. Panel replacement.....	22
VII. Contact info, schedule audits, etc.....	22

This installation booklet is intended to show the basic information needed to properly install Porcelanosa's Porcelain Façade System.

Installation training is recommended and provided by Porcelanosa free of charge at our training facility in Paramus, NJ.

Always check the web site for the latest technical information, including construction details, test summaries, specifications and more, at Porcelanosafacades.com

Porcelanosa Façades Systems must be installed in accordance with the latest published installation instructions. Contact Porcelanosa Facades Technical Department for questions and additional information, at 201-995-1310 x2017.

I. GENERAL RECOMMENDATIONS

Please follow the instructions issued by site management.

Verify the information contained in the modulation documents and façade project. Check the information contained in certificates, data sheets and packing material. Employ only properly-qualified persons and suitable tools.

A. Structural Requirements (design assist info, shop drawings)

The system must be installed over wall assemblies complying with the latest building code. For stud walls, Porcelanosa Porcelain Facades require a minimum 16-gauge stud spaced a maximum of 16" on center. For solid walls please refer to your project design guide. All projects must include the substructure components as outlined in your individual project's shop drawings.

Porcelanosa Porcelain Facades provides detailed shop drawings specifically tailored to each project. As such, it is imperative to follow these shop drawings exactly as drawn. These drawings include thermal allowances, design pressures and any special considerations that must be taken to successfully install the product in optimal time. Deviating from these instructions and from the supplied shop drawings may cause a loss in product warranty.

Please contact the Porcelanosa Porcelain Facade technical department for questions or assistance at any point throughout the project.

B. Weather Barrier/Water Penetration

All exterior wall assemblies must include appropriate flashing, a water-resistive barrier and proper water shedding and drainage as mandated by the latest building code. Porcelanosa will not be responsible for water penetration into the substructure.

C. Product Inspection

As soon as product is received and before installation, inspect panels and profiles and check for defects, proper color, etc.

It is recommended to collect the material in an orderly and responsible manner. If possible, keep small and valuable items locked. This can prevent the deterioration of boxes and packaging and also the disappearance of materials.

Porcelanosa Facades is not responsible for the lack of materials as we are not present at the job site.



D. Handling

At the time of handling the materials it is imperative to be careful not to hit them, as we could cause a break in the material, or weaken it without appreciating any breakage.

It is common sense that depending on the size and weight of the panel, it will be moved by one or more people.

Porcelanosa recommends that if you have to leave the panel somewhere after it has been removed from the original package, it is done on a soft base, such as a carton, foam, etc. Not directly against the floor.

E. Contact information for technical department

Contact the Installation Manager: Borja Domenech at (201) 995-1310.

F. Profiles

The Porcelanosa Porcelain Facade system is comprised of the following elements:



- The substructure profile system. A patented system to provide a thermal break, makes room for insulation materials to meet latest IECC/ASHRAE requirements for R value and U factors as well as allows the framing tolerances of + or - 3/4"
- All vertical profiles and fixing clips are powder coated with corrosion resistant proprietary finish to prevent galvanic reactions with fasteners
- All vertical profiles feature a friction surface in order for construction adhesive to properly set in place
- All system profile/substructure pieces are essential to the performance of your Porcelanosa Façade and any deferment or fabrication by others will void the warranty
- The Omega, or hat channel (installed, horizontally into framing members)
- The T and L profiles (installed vertically over Omega)
- The Angle brackets used to attach T (vertical joints) and L profiles (anywhere else that T profiles are not used) to the omegas, with a thermal break patented piece to eliminate thermal bridging, installed between the two
- There are 4 types of Fixing clips, which are used to attach the porcelain panels to the T and L profiles:
 - * The Top/Bottom clip used on the top and bottom rows of porcelain panels
 - * The lateral clip for ends and bumpouts
 - * The staggered clip, when porcelain panels are installed in a staggered bond
 - * And the central clips, typically at all 4-corner joints

G. Porcelain Panels

The porcelain panels are the star of the installation. These are highly durable, completely water proof, easy to clean, resistant to graffiti, strong, and noncombustible.

The panels are fitted with a fiber-glass mesh for added strength and safety.

The porcelain panels are specific to each individual project and are precisely cut and kerfed at the factory to fit your project. This will make installation much faster and reduce the amount of cuts needed in the field.

H. Fasteners

One of the unique features of Porcelanosa Porcelain Facades is that we ship all the fasteners to you so you have one less thing to worry about purchasing. We even tell you where to use each fastener in our customized shop drawings for your project.

Every fastener is clearly labeled with its application, whether that is omega to stud, omega to concrete, profile to omega, or fixing clip to profile.

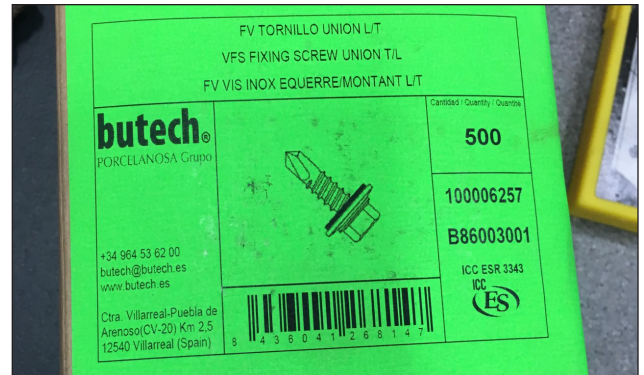

I. Wall sections (stud and solid) and elevation details

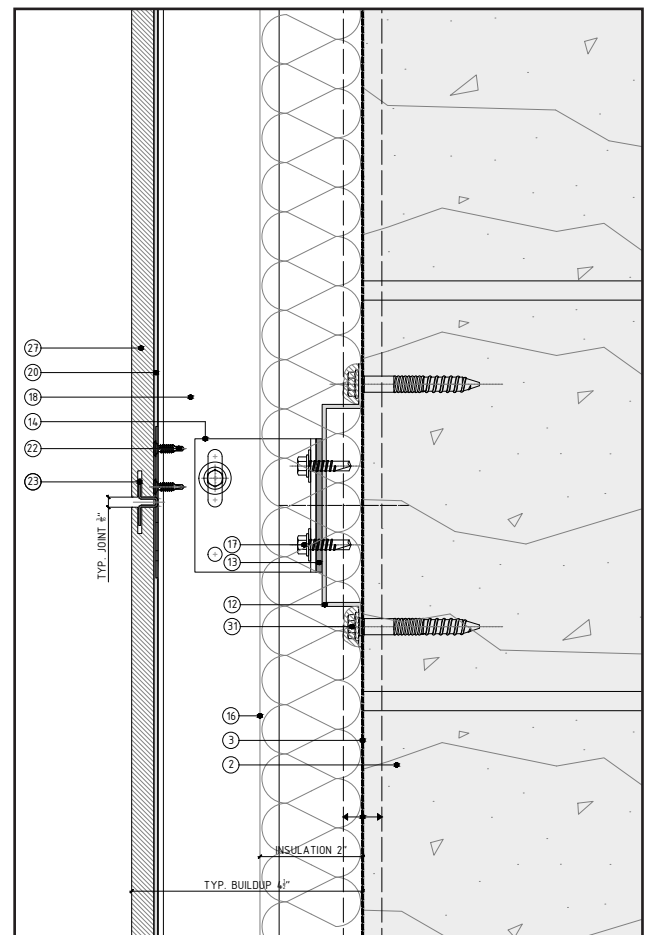

SOLID WALL SECTION EXAMPLE

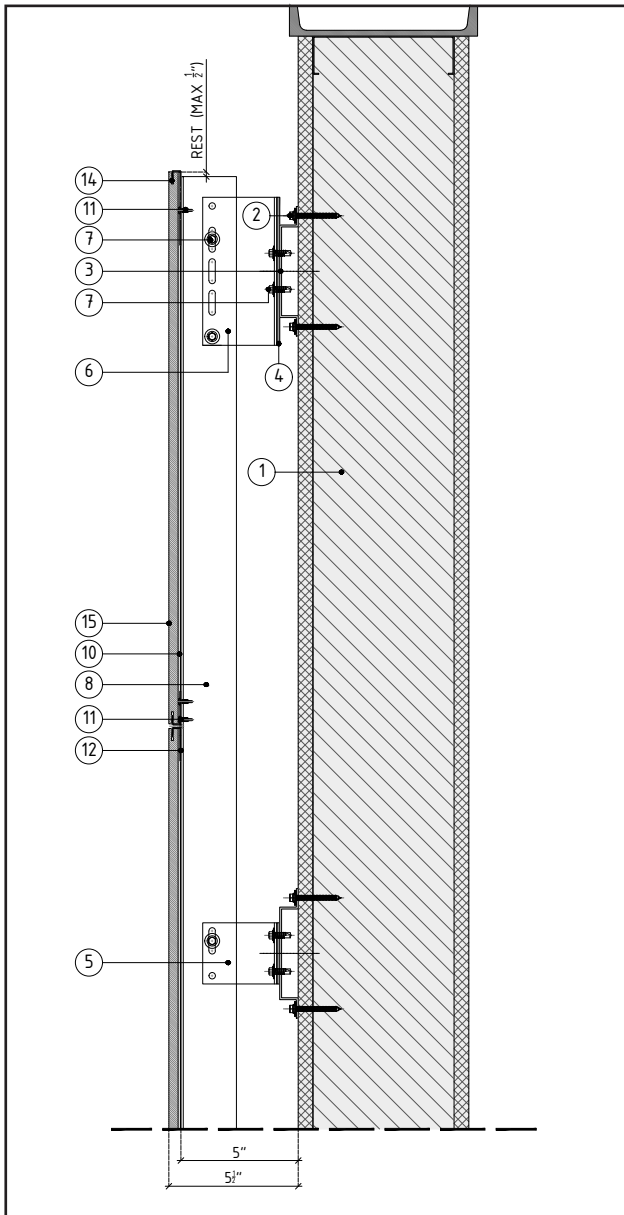

STUD WALL SECTION EXAMPLE

II. SAFETY

SAFETY INSTRUCTIONS FOR CERAMIC TILES

Made from raw materials of mineral origin (mainly clays), which have been mixed with water, dried, formed, and fired in high-temperature kilns. They may have a glaze surface coating that has been fired together with the body.

They are used as construction elements to cover façade, wall, and floor surfaces.

EMERGENCIES

OSHA: 1(800)321-6742

Call OSHA to report emergencies, unsafe working conditions, safety and health violations, to file a complaint, or to ask safety and health questions. The Occupational Safety and Health Administration is an agency of the United States Department of Labor.

.....

The information detailed here is based on our knowledge at the date stated; it refers exclusively to the product indicated and does not constitute a guarantee of particular qualities. The user is responsible for using the product in accordance with the recommendations provided.

.....

A. DANGERS

No adverse effects are known for health or the environment of whole tiles.

In certain handling processes (cutting, edge-grinding or rectification, disposal, etc.) dust may be produced that could irritate the exposed body parts owing to its abrasive effect.

The dust released in these operations contains respirable crystalline silica (RCS), whose inhalation could cause acute or chronic silicosis (nodular fibrosis of the lungs), depending on the quantity and exposure time. Epidemiological studies indicate that silicosis is a risk factor for lung cancer.

The quantity of RCS contained in the dust that tiles might release during handling varies, since this depends on dust composition and the size of the particles involved (RCS has a particle size below 4 µ). A preliminary study conducted on the dust in rectification water shows a respirable crystalline silica percentage far below 1%.

B. FIRST AID



Inhalation of dust:

Take the affected person outdoors. Give artificial respiration if necessary.



Contact with eyes:

Hold the eyes open and wash with abundant water.

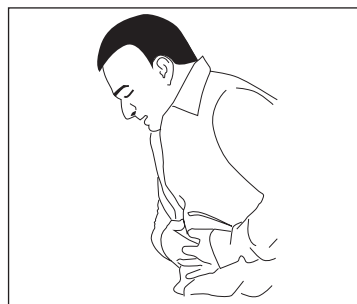

Ingestion of dust:

Highly unlikely route. The product is neither toxic nor is it retained in the intestinal tract.

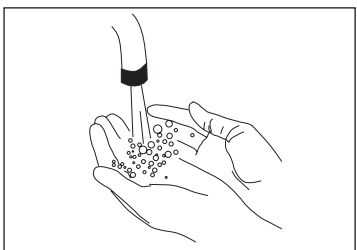

Contact with skin:

Wash with soap and water. In the case of a cut, proceed according to the seriousness of the injury.

C. STORAGE

Ceramic tiles need no specific conditions to assure safe storage and they exhibit no incompatibilities with other products or materials. They have a very long working life since they are not readily degraded.

D. DISPOSAL

Tile wastes are classified as inert materials, so that they can be disposed of at an authorized disposal site in accordance with applicable regulations.

E. TRANSPORT

Ceramic tiles are considered non-hazardous for transport according to the international criteria on earth, sea, and air transport.

F. SAFE HANDLING

The measures described refer to processes that involve the production of dust and/or breaking of tiles, such as cutting and rectification.

GENERAL MEASURES

Have good ventilation in the workplace. Avoid dust formation and dispersal. It is recommended that wet working methods should be used that reduce or avoid dust production. If this cannot be avoided, there should be a localized extraction system or the material should be handled in a closed system. Regularly collect the dust that forms by suction or wet cleaning mechanisms.

PERSONAL PROTECTION

During tile handling.

Use gloves to prevent possible cuts and scratches. Safety footwear to prevent possible foot injury because of tiles falling on feet.

During processes that produce dust.

Respiratory protection, safety glasses, and suitable clothing to prevent exposure to dust.

It is recommended to consult suppliers of individual protective equipment (IPE) to determine the most appropriate IPE as a function of the workplace and dust concentration.

FIRE PREVENTION

Ceramic tiles are non-combustible.

Observe standard fire protection regulations.

ENVIRONMENT PROTECTION

Clean possible discharges and emissions taking into account the applicable limit values.

III. RECOMMENDED TOOLS

Porcelanosa Porcelain Facades can be more easily installed with the tools listed below. Having these on hand will make for a faster and easier installation.



CLAMPING TOOLS



BEATING TOOLS

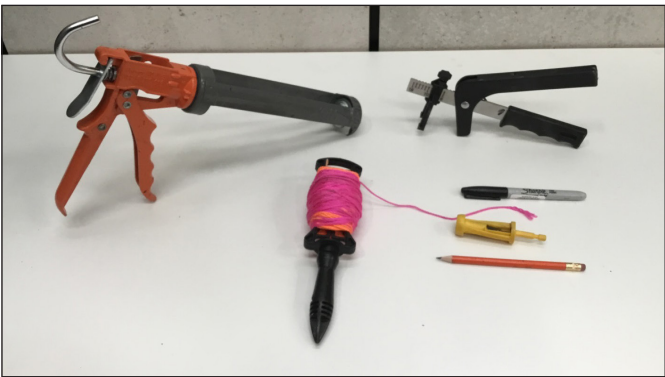

HAND TOOLS



ELECTRIC TOOLS



LASER LEVELS



SAFETY ITEMS



HAND LEVELS AND ADJUSTMENT TOOLS

IV. INSTALLATION

A. Preparing the substrate (planning, layout, etc.)

Check to ensure that the façade support coincides with that specified in the project.

Please notify the General Contractor AND PORCELANOSA Installation Manager immediately if the substrate wall at the jobsite is different to what is specified and shown in the shop drawings.

Check to ensure that the support or installation base is stable and not likely to become deformed or cracked. The support must be subject to vertical deviation of no more 1/8" every 3 ft, and horizontal deviation of no more than 3/8" for every 6 ft.

Determine the final level of the façade with respect

to overhangs, cantilevered elements or any item that protrudes beyond its vertical plane.

Take structural joints into account, and consider the use of expansion joints.

Check to ensure that the supporting and anchoring elements of the substructure of the façade conform to the required technical specifications.

Check that the actual measurements of the façade coincide with those shown on the plans. If they do not, amend the modulation documents and façade-installation plans accordingly.

Determine the reference or setting out point/s of the façade.

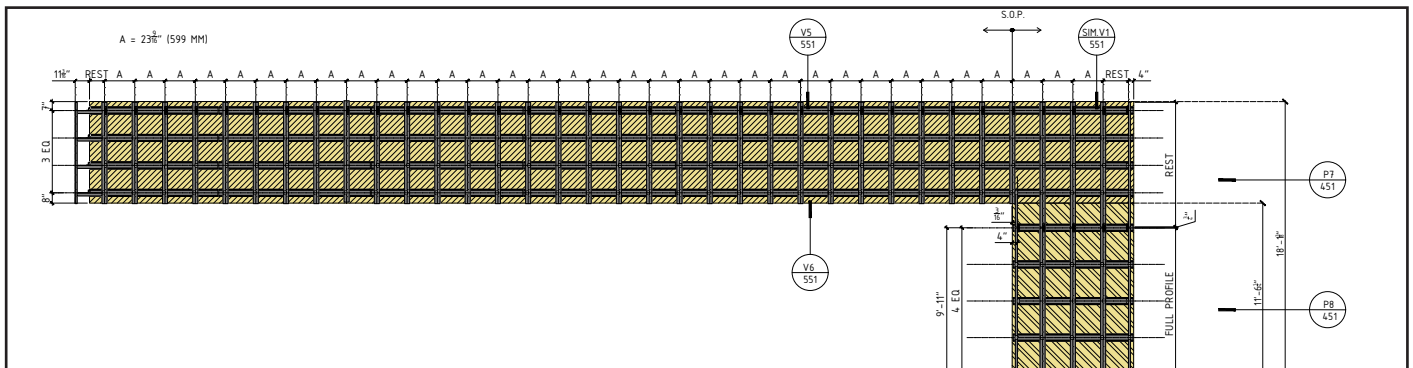

STRUCTURE SETTING OUTPUT EXAMPLE

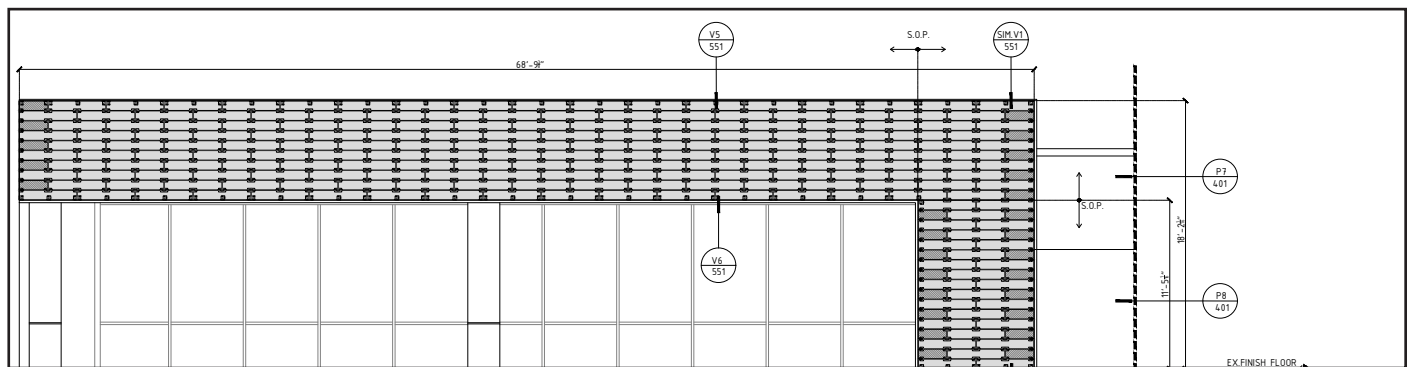

PANEL SETTING OUTPUT EXAMPLE

Using the reference point of the façade as a starting point, and on the basis of its modulation documents, mark the support to show the position of the substructure profiles. Distance of ≤ 66 cm

Mark the position of the profiles on the surround and at other critical points.

Use the thickness of the thermal-insulating material and the overhang of the façade as a basis for determining the height of the aluminum angle brackets that correspond to the different areas of the façade. The level-deviation of each aluminum angle bracket must not exceed 20-30 mm.

B. Install substructure (omegas)

The Omega profiles are made of Al-Mg-Si alloy 6005 coating in accordance to ISO specification.

Make sure the water resistive barrier has been properly applied to the substrate prior to Omega installation.

Check the stud wall for plumbness prior to chalking line. Ensure you allow for proper hardscape or finished soil grade clearances.

Fasten the omega profiles in horizontal position (with the help of a laser level) to the substructure according to the project's shop drawings provided. Install the omega profiles next to each other, along the longitudinal axis. Leave a 3/4" gap between profiles.



Once the first horizontal line is installed, the next row of the omega profile must be placed according to shop drawings and never more than 30" o/c.

Omega Profiles must be fixed using at least two screws every metal stud. One screw on each side of the top hat profile positioned within the pair of ridges. The pair of the screws must be fixed in line, with the longitudinal axis for the metal stud frame.

FIGURE 1: CLADDING SYSTEM TOLERANCES

*IN-AND-OUT TOLERANCE = +/- 3/4" (20MM)

*IF WALL IS BEYOND SYSTEM MAX TOLERANCE, ADDITIONAL SPACER L-BRACKET MUST BE USED. FACADE INSTALLER MUST CONSULT WITH PORCELANOSA

SITE SITUATION 1: WALL IS VERTICALLY PLUMBED
 SITE SITUATION 2: WALL CAN BE FURTHER OUT BY 3/4"
 SITE SITUATION 3: WALL CAN BE FURTHER IN BY 3/4"

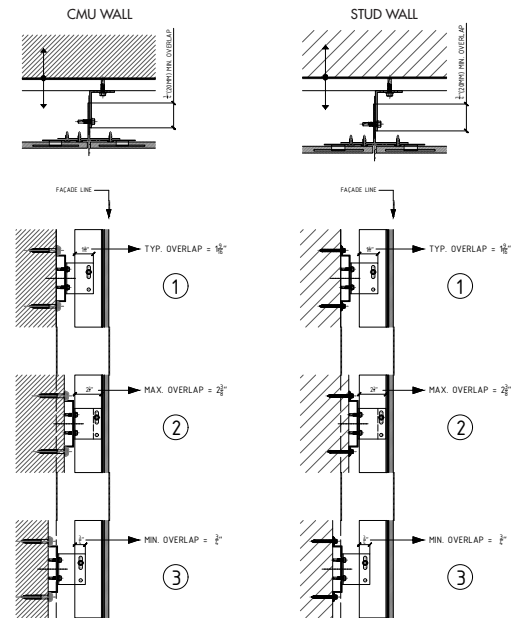

IMPORTANT NOTE: Porcelain Panel system is assumed to be supported by 17 gauge studs provided at maximum 16" O.C. It is the installer's responsibility to ensure that the connection of the porcelain panel system is to the correct gauge framing, and at the frequency and locations indicated in this shop drawing submittal.

FIGURE 2: VERTICAL PROFILES TO L-BRACKETS

METHOD 2: CONTINUOUS FIXING OF VERTICAL PROFILES

*RECOMMENDED METHOD FOR LOW RISE BUILDINGS

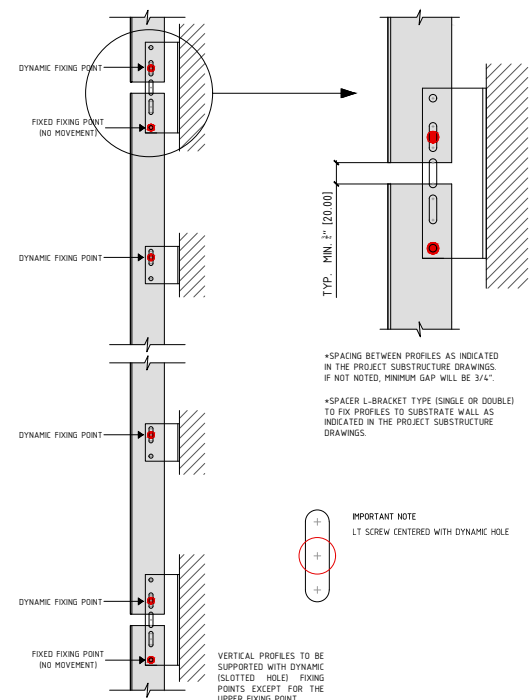

FIGURE 3 - P-404 LOCATION IN VERTICAL PROFILE ACCORDING TO TILE POSITION

*ONLY APPLICABLE WHEN METHOD 2 (CONTINUOUS FIXING OF VERTICAL PROFILES) IS USED
 P-404 TO BE LOCATED WHERE THERE IS GREATER OVERLAP WITH VERTICAL PROFILES.
 SITUATION 1: GREATER OVERLAP ON PROFILE ABOVE HENCE ADHESIVE TO BE USED ONLY ABOVE
 SITUATION 2: GREATER OVERLAP ON PROFILE BELOW HENCE ADHESIVE TO BE USED ONLY BELOW

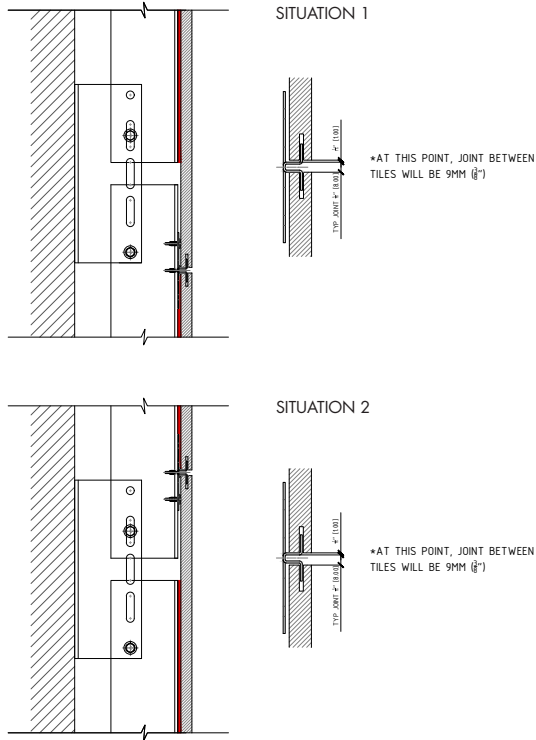

FIGURE 4 - NO. OF FIXING POINTS AND LOCATION OF SPACER L-BRACKET

WITH OMEGA
 DOUBLE BRACKET: 2 IT SCREWS
 SINGLE BRACKET: 2 IT SCREWS

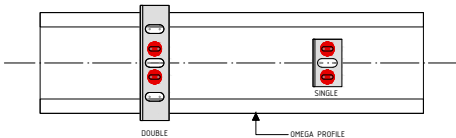

FIGURE 5 - MAXIMUM VERTICAL SPACING BETWEEN ANCHORS TO SUBSTRATE WALL

*THE SAME CRITERIA WILL BE USED FOR SPACING BETWEEN LBRACKETS IN SOLID WALLS
 *SPACING AS INDICATED IN THE PROJECT SUBSTRUCTURE DRAWINGS. IF NOT NOTED, FOLLOW THIS

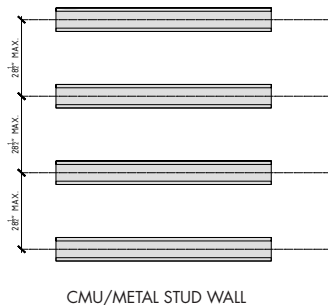

FIGURE 6 - SPACING BETWEEN VERTICAL PROFILES

*SPACING BETWEEN VERTICAL PROFILES AS INDICATED IN THE PROJECT SUBSTRUCTURE DRAWING
 IF NOT NOTED, MAXIMUM SPACING WILL BE 23 9/16" (599 MM)

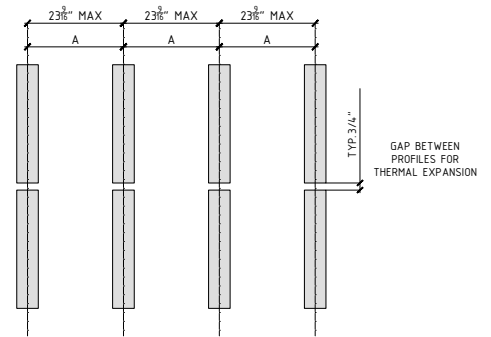
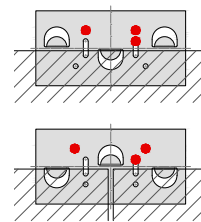
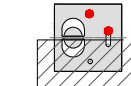

FIGURE 7 - LOCATION AND NO. OF FIXING POINTS IN FIXING PLATES

STAGGERED
 3 FIXING CLIP SCREWS



LATERAL
 2 FIXING CLIP SCREWS



START & ENDING
 ENDING: 3 FIXING CLIP SCREWS
 START: 4 FIXING CLIP SCREWS

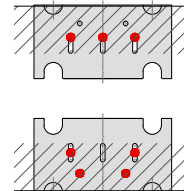

START & ENDING HALF
 ENDING: 1 FIXING CLIP SCREW
 START: 2 FIXING CLIP SCREWS

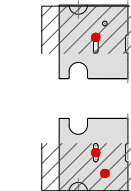

FIGURE 8 - ANCHORING MINIMUM DISTANCE TO EDGE OF WALL

*IN CASE THAT NEED TO BE LESS, CONSULT WITH PORCELANOSA

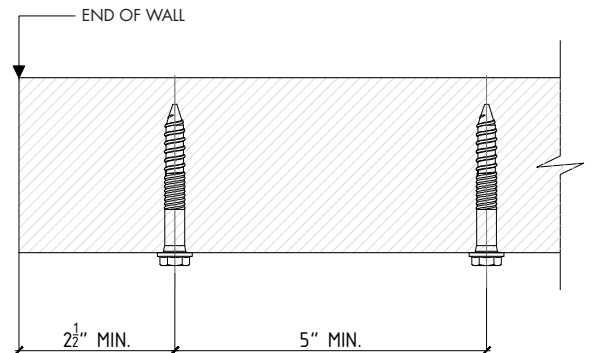

FIGURE 9 - LOCATION, SPACING AND NO. OF FIXING POINTS OF HORIZONTAL PROFILES

*SCREWS SPECIFICATION WILL DEPEND ON TYPE OF STUD (METAL/WOOD) - REFER TO SCREW SCHEDULE

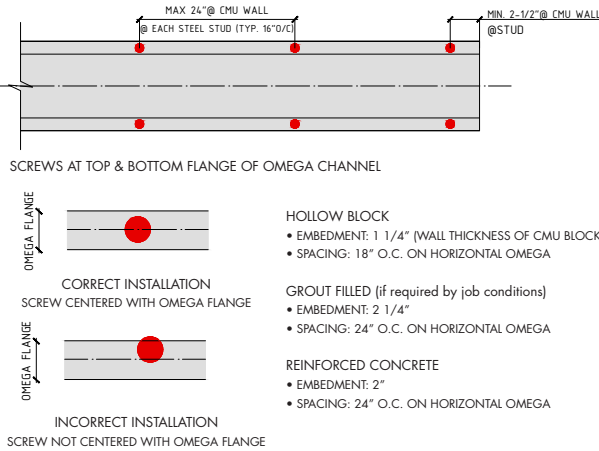

FIGURE 10 - FIXING METHODS - P-404

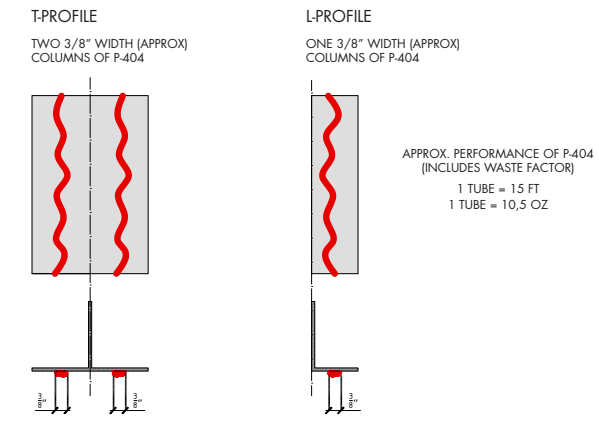
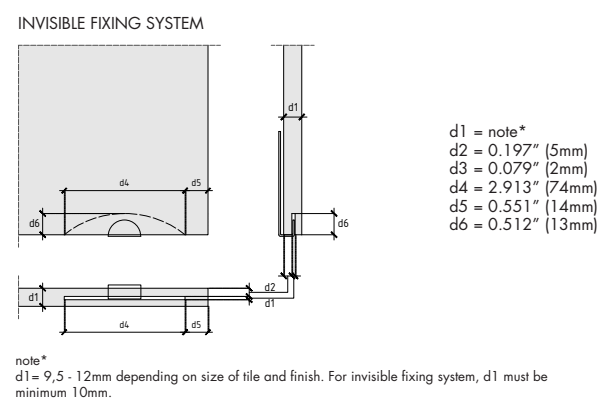

FIGURE 11 - LOCATION AND DIMENSIONS OF FIXING PLATES AND KERF SAW CUTS



The omega profile must be fastened to the stud wall, at each stud location using the screws as specified in shop drawings, and provided with your shipment.

All self-drilling screws must have EPDM sealing washers. Typically these are included with your material order.

C. Insulation Install

Please note, the use of insulation is not required for installing Porcelanosa Porcelain Facades and is strictly at the discretion of the building designer.

Ensure at minimum 1-1/4" (30mm) air space between the back of the porcelain and the insulation material, in order to ensure that natural upward convection takes place behind the cladding material.

The type, thickness and characteristics of the thermal-insulating material are to be defined in terms of the project.

Lay the thermal-insulating material in accordance with the instructions provided by the supplier. We recommend the following with respect to the substructure of the facade:

- Projected polyurethane (PU): Lay the insulating material after installation of the aluminum angle brackets and the profiles corresponding to the substructure. Porcelanosa recommends keeping the plastic film in the profiles until the projection of the insulation is finished to keep the surface clean. This will prevent cleaning work and the P-404 will work in perfect condition.
- Polystyrene (PS) panels: Lay the insulating material before the installation of the aluminum angle brackets corresponding to the substructure.
- Check to ensure that the layer of thermal insulating material is continuous, and that there are no thermal bridges still to be dealt with.

D. Angle Brackets

The angle brackets are used to secure the vertical profiles to the horizontal omega profiles. The brackets are the element used to adjust the lead of the facade. The size of these will be indicated in the shop drawings, but may vary depending on whether the building is plumb. The size of the brackets changes in steps of 3/4 ".

There are two types of angle brackets used in every installation: The primary brackets, which are typically used only at the top of a vertical profile, and secondary profiles, which are used everywhere else. Please refer to your shop drawings for vertical profile and bracket type and placement. Also indicated in the shop drawings how many screws, and where they are installed. It is very important to check this point and install the screws as indicated in the shop drawings so that the system works correctly in the expansions.

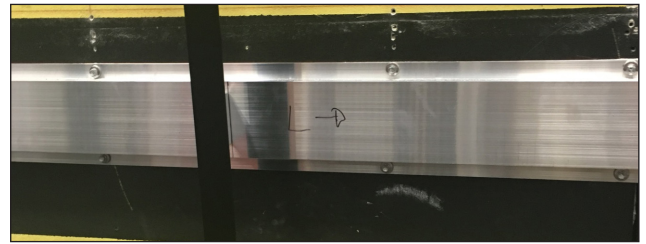

There must be a minimum $\frac{3}{4}$ " overlap between the angle bracket and the profile.

Make sure all vertical profiles are level, aligned and in the same plane.

The secondary brackets will be placed everywhere that a primary bracket is not used.

The shape of the aluminum angle brackets alternates in line with the flange of the supporting anchoring element.

When installing directly to a solid wall, CMU or brick, anchor the aluminum angle bracket at a joint between bricks.

Your Porcelanosa Porcelain Facade System comes with special, patented thermal break pieces that are installed between the angle brackets and the omega profile, in order to prevent a thermal bridge.

E. T and L (Vertical) Profiles

The vertical profiles serve as the base for the ceramic panel installation.

They come in two shapes: The T and the L. The T vertical profile is used at every vertical joint between ceramic panels. The L profiles are used as additional supports anywhere the T vertical profiles are not used and for inside and outside corners, bumpouts, etc.

You must reference your project-specific shop drawings to denote the following:

- Location of each type of profile on the wall
- Which way the L profiles are facing (which depends on the angle bracket placement)
- Location of the bottom of each profile (prior to installation)
- Taking the time to mark the omegas at the angle bracket locations as to which way the L profiles are facing will make it easier to install.

F. Porcelain Panels

Porcelanosa Porcelain Facade System features a double anchor system which provides maximum wind resistance. First, the chemical anchoring, which also helps to dampen vibrations at high altitudes consist of a line of polyurethane construction adhesive p-404, provided with your shipment (refer to installation instructions below). Secondly, the system also features mechanical anchoring in the form of corrosion-resistant, Stainless-steel fixing clips.

1. Cutting panels, Kerf Cut instructions

Panels will be delivered already cut to size for most areas of the project. Please check your project-specific shop drawings prior to cutting any panels as they may already be assigned to other areas or elevations.

In full size typically 1 or 2 standard sizes. This is a cladding system that allows for easy dimensional adjustment of panels at the jobsite, avoiding the need for verified in field dimensions prior to start with shop drawings, saving time. Also, since the design is optimized and the façade uses as many full panels as possible, the need for field cutting and kerf-cutting panels will be minimized.

These instructions pertain to panel and kerf-cuts that are unavoidable on site in order to fit around certain corners, windows, bumpouts, or as specified in the shop drawings, or where building significantly differs from shop drawings. Please contact the Porcelanosa Facades technical department with any questions regarding field panel cutting and kerf-cutting/slotting.

You must cut the porcelain panels using an electric ceramic wet saw such that the saw:

- Feature a continuous cutting band.
- Are suitable for tile thicknesses under 1" (25 mm)

- Are available for the following diameters: 7", 9", 12" and 14" (180, 230, 300, and 350 mm)
- Provide water cooling



You can also cut the panels with a manual ruby machine. This cutting requires less time, and can be done with a more economical machine. However, the quality of this cut is inferior, and we would have to review the edge of the piece with a sander to make it aesthetically correct. Also it is necessary to take into account that with this machine is difficult to obtain a totally straight cut.

a) Kerf saw cuts in porcelain tiles

Kerf saw cuts, placed along the edges of porcelain panels provide the space for placement of the fixing clips. These are the key to the hidden fastening system on the Porcelanosa Porcelain Facade System.

The number and type of slots depends on the porcelain panel dimensions and the design of the project.

The kerf saw cut characteristics, as well as its tolerances, are listed in Appendix I of the on-site cutting and kerf saw cutting manual. As mentioned above most panels will come cut from the factory and ready to install, but in some areas such as bumpouts, windows, doors, inside corners and such, there may be the need to cut the panels on site to allow for fixing clip attachment to the structure.

Porcelanosa USA sells a customized biscuit joiner that has been retrofitted with a water pump to provide a wet saw environment and allow for safety when cutting the porcelain. See photo below for reference.

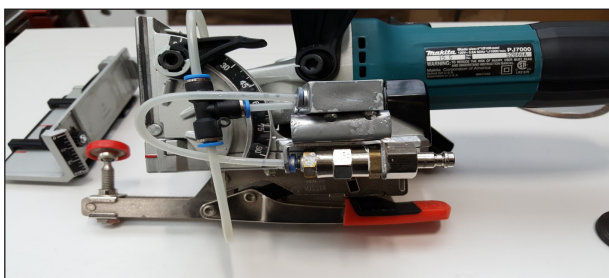

2. Starter clip

Position a straight edge horizontally at the starting-point of the façade.

Screw the leading stainless-steel fixing clips to the profiles. When working with a lateral leading element, use the lateral fixing clip.

Apply a line of p-404 to the vertical profile.

Place the porcelain panel, with the corresponding slot and offset, onto the flange of the stainless steel fixing clip, and press it down while the polyurethane mastic is still not set.

Check to ensure that the panel is securely stuck to the profile, and that it is level with respect to the façade.

3. Vertical and horizontal panel joints

Once the panels are installed the joints must be aligned and of a same size throughout the facade.

The fixing clips provide the horizontal joint, and with the help of a rubber hammer we will hit the panels to make small adjustments.

To facilitate the installation, Porcelanosa provides plastic spacer/shims with the corresponding measurement to the typical joint of each project. Use these in order to have the proper joint spacing and leave them in place until the polyurethane adhesive (p404) is dry.

4. p-404 instructions

APPLICATION OF P-404 FOR VF

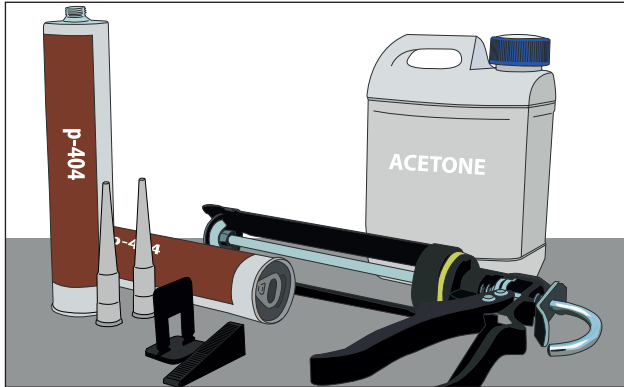

Step 1. Materials Required:

- **p-404** adhesive.
- Alcohol or Acetone.
- Caulking gun, tip and wedges.

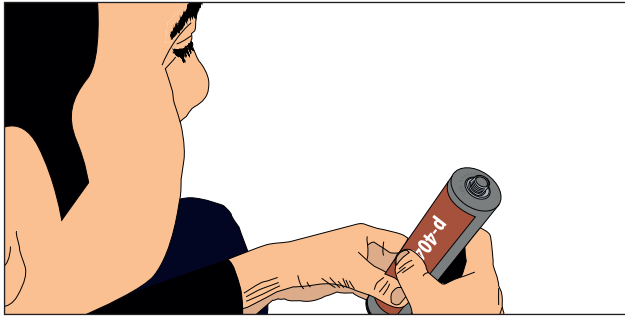

Step 2. Check Condition

- Check expiration date.
- Check the container is in good condition.



Step 3. Precautions in Extreme Weather

- Application of **p-404** adhesive requires no special precautions between 40 - 95°F (5 - 35°C).
- Below/above this temperature, the use of thermal protective bags is mandatory until the moment before its application.
- In order to keep the adhesive in good working condition, it is highly recommended to maintain it warm inside the thermal bag between uses.

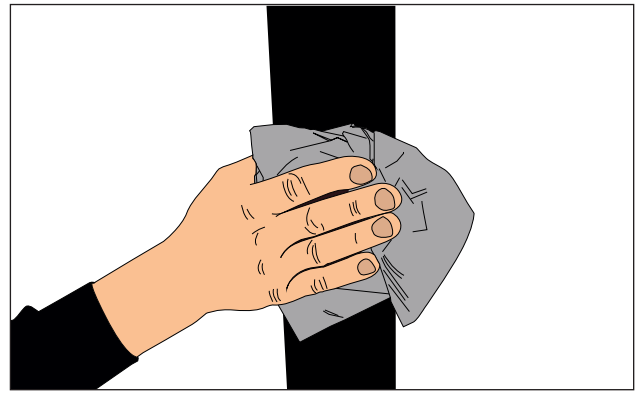

Step 4. Clean Substrate

- The substrate must be completely clean and dry.
- It is recommended to clean the substrate with alcohol/acetone and dry afterwards.

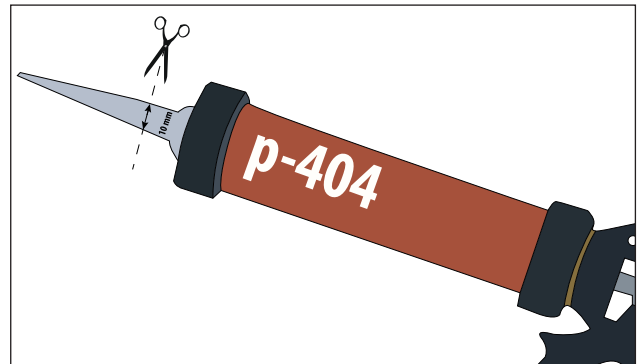

Step 5. Instruction to Cut Tip

- The tip must be cut at a straight angle for a hole precisely 0.4" diameter (10 mm).

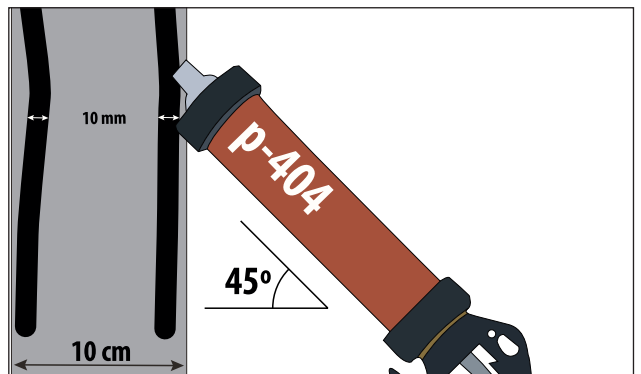

Step 6. Instruction to Apply the Adhesive

- A continuous bead of adhesive must be applied with the caulk gun at an angle as shown above.
- The minimum bead of adhesive is 0.4" diameter (10mm) which equates to 4.92 feet of profile/cartridge.

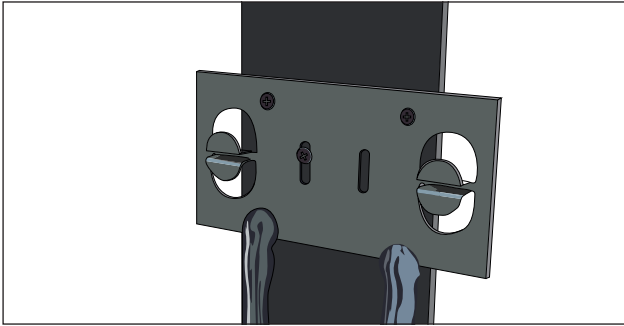

Step 7. Extent of Application

- The adhesive must be applied to all along the length of the panel and must overlap with the fixing plate as shown above.

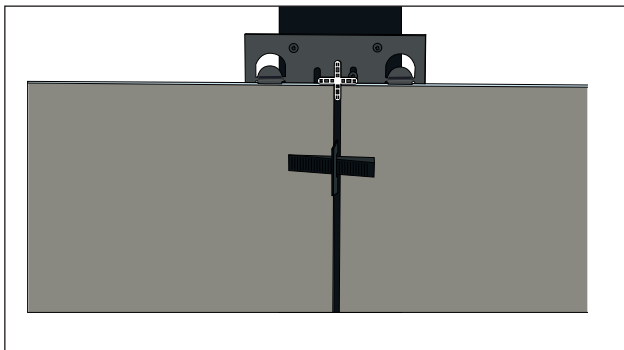

Step 8. Ensure Quality of Installation

- For the highest quality of installation, the use of wedges is obligatory.
- The minimum time for the wedges to stay is 24h. With this said, the longer the wedges stay in place, the better.

It takes approximately 28 days for the p-404 to cure.

Be sure to check expiration date on the p-404 tubes, as they have about a one-year shelf life.

5. Rest of courses (end points)

The leveling wedges are already installed from the first row, in the vertical joints.

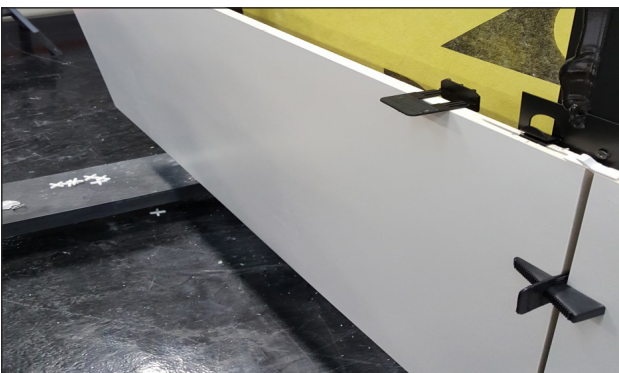

The leveling wedges are another element of support to the installer during the installation of the system. This item must be used during the installation, and makes the panels align and do not protrude more than another. As much as possible, they should be kept in the facade as long as possible, this will help the panels not to move during installation, and while the p-404 adhesive is completely dry. (28 days).



Depending on the layout, insert the lateral or central stainless-steel fixing clips into the ceramic panels of the previous row. Screw the stainless-steel fixing clip to the profile.

Apply a line of polyurethane mastic p-404 to the vertical profile.

Place the ceramic panel, with the corresponding slot and offset, onto the flange of the stainless steel fixing clip, and press it down before the p-404 sets.

Check to ensure that the panel is securely stuck to the profile, and that it is level with respect to the façade.

Insert a wedge into the self-leveling crosspieces of the previous row, and adjust accordingly.

Once the second row is complete, insert the self-leveling cross-pieces, and start to install the rest of the façade.

6. Termination (with roof cap, open, and as coping)

Configure the surrounds and openings of windows in accordance with the directions issued by site management. Check for leaks at the joints between the surrounds and the façade.

Check the joints between the façade and the remaining sealing elements.

Once the last row is in place, install the terminal element of the façade. We recommend the use of an aluminum profile with weatherproof finish.

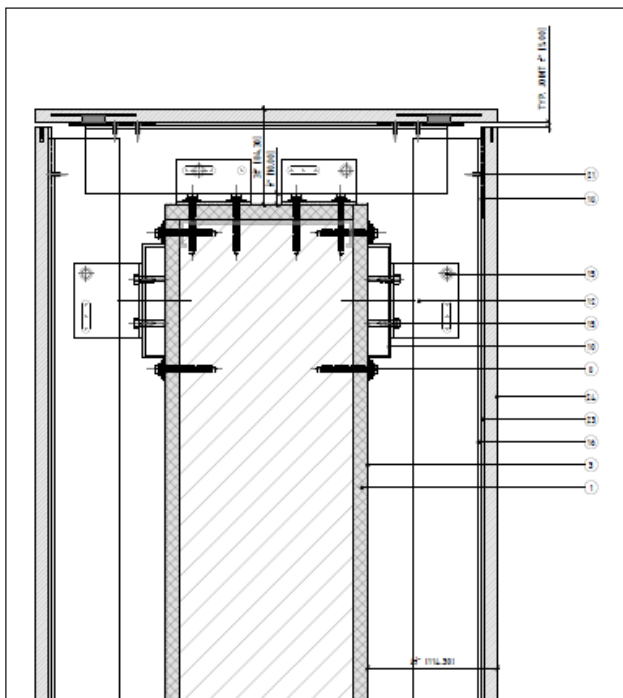

TERMINATION WITH TILE

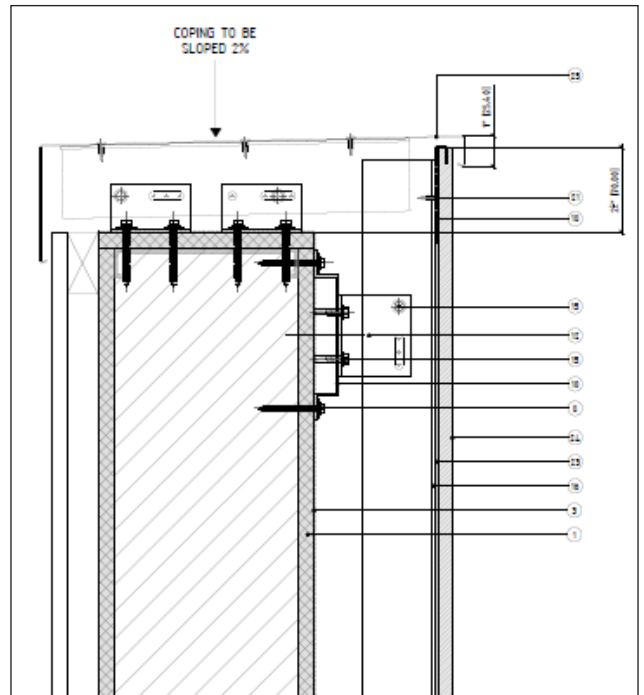

TERMINATION WITH METAL FLASHING/COPING, BY OTHERS

7. Doors and Windows

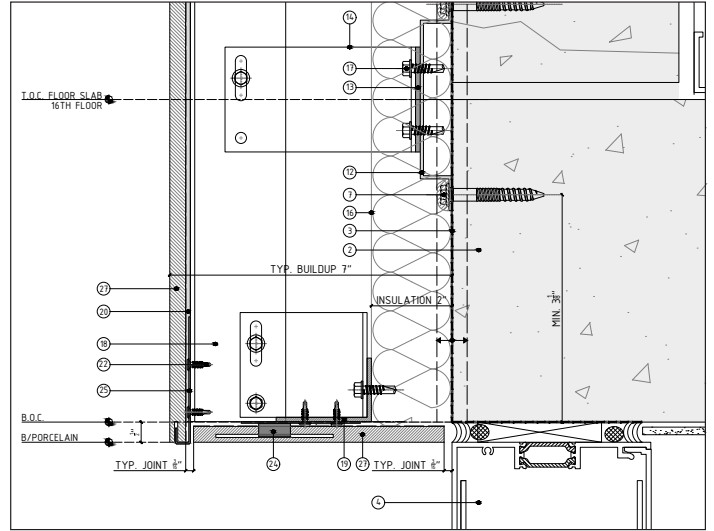

WINDOW HEAD EXAMPLE

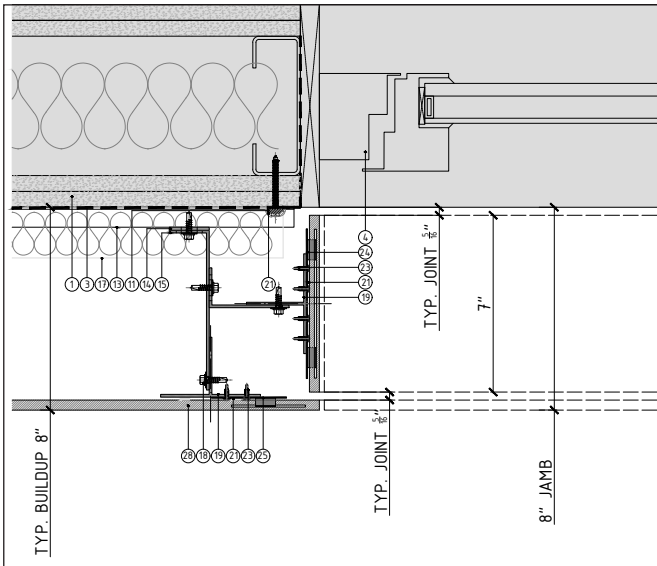

WINDOW RETURN EXAMPLE

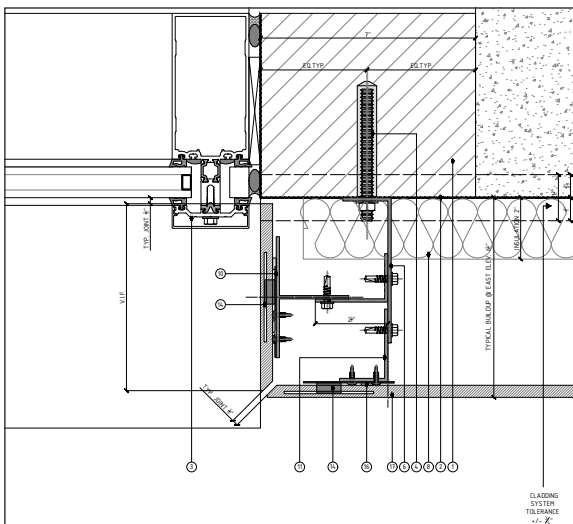
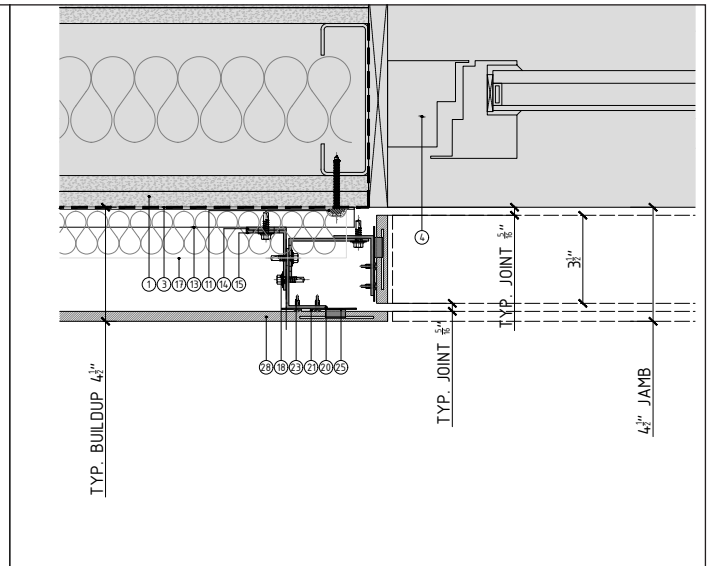

WINDOW RETURN + MITER EXAMPLE

8. Corners

The installation of the corners, are the most critical point of the projects. It is the area where the system allows less play, and is the zone in which we must install the most perfect sub-structure possible if we want the aesthetic and structural finish is correct.

All shop drawings include pages with the specific detail of corner construction.

a. Outside

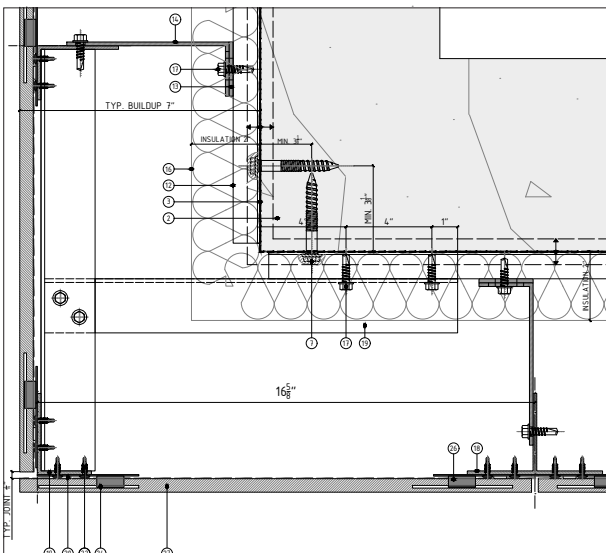

EXTERIOR CORNER EXAMPLE

b. Inside

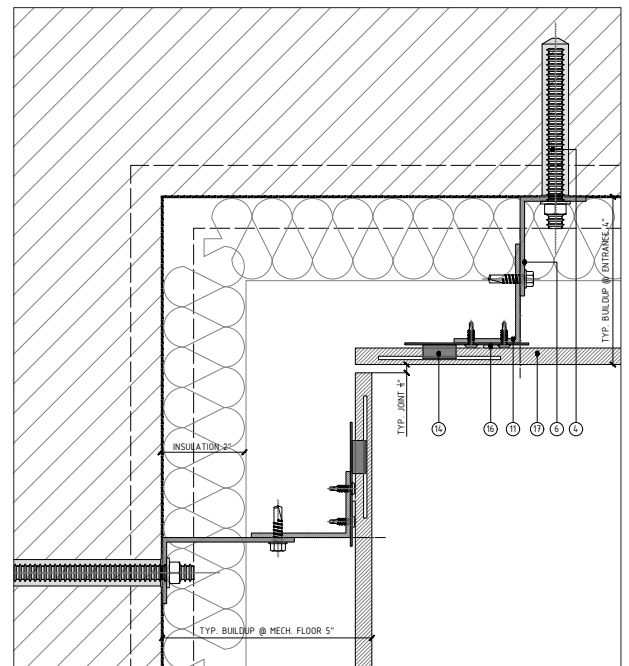
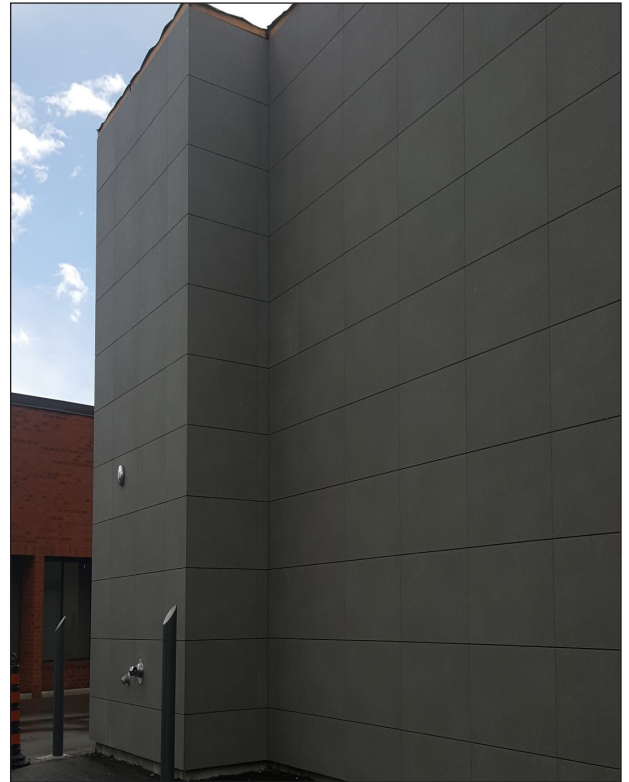

INTERIOR CORNER EXAMPLE

c. Field Mitered

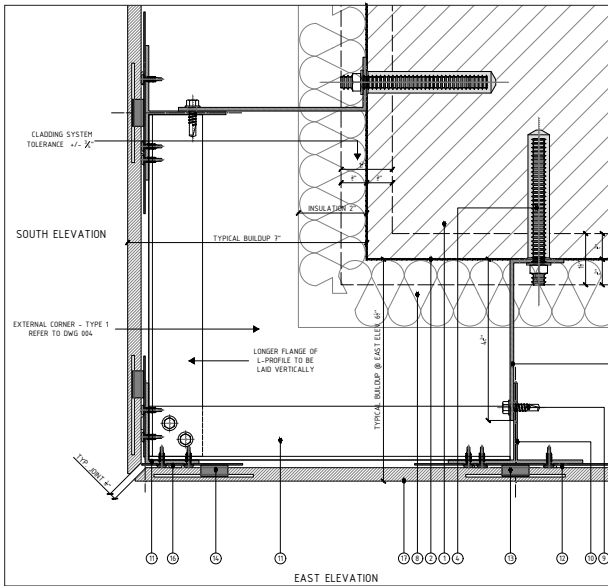

EXTERIOR CORNER + MITER EXAMPLE

d. Sloped Grade/Roof Rake

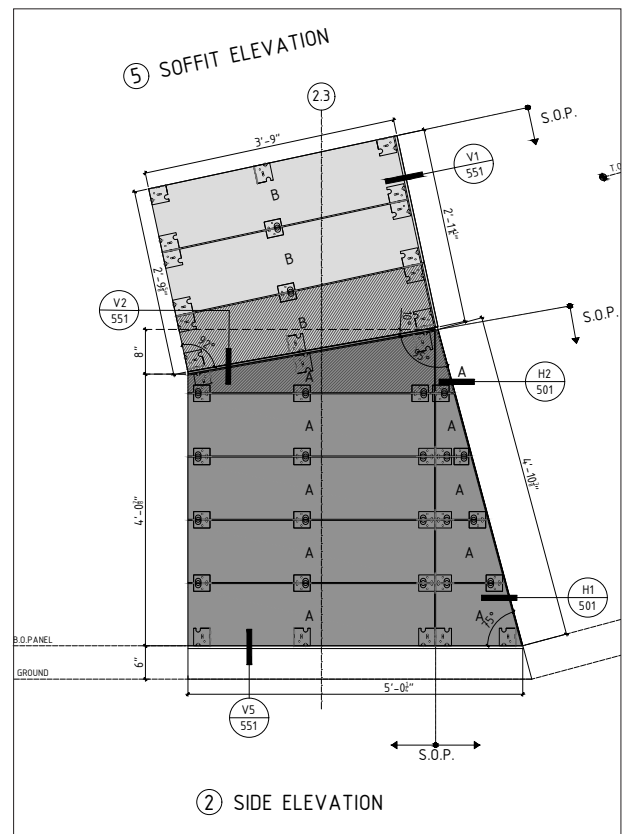

SLOPED GRADE EXAMPLE

V. CLEANING AND MAINTENANCE

A. Initial cleaning of the façade

Once all the construction activities and works are finished, that may produce dirt or residue and therefore affect the appearance of the façade:

- Clean with pressurized water and dry with a clean cloth.
- In the case of stains that resist normal washing, clean again with water and mild soap.
- Never use abrasive elements or detergents that are different from those indicated.
- Use qualified personnel and appropriate tools.

Before the initial cleaning, check the information contained in certificates, technical data sheets, and packaging.

B. Regular cleaning

The direct contact of the façade with the air and therefore with environmental pollution, as well as with any kind of vapor, gas, liquid, or element coming from the building or the outside, can produce dirt deposits that can affect the appearance of the façade. Since PORCELANOSA Group's STON-KER slabs are characterized by their zero absorption (less than 0.5%), dirt does not penetrate, it only remains on the slab surface.

- Clean with pressurized water and dry with a clean cloth.
- In the case of stains that resist normal washing, clean again with water and mild soap.
- Do not use solvents or concentrated acid detergents.
- Never use detergents containing hydrogen fluoride (HF) in their composition.
- Do not use detergents containing waxes in their composition.
- Never use abrasive elements that may scratch the ceramic slabs.

The cleaning frequency will depend on the degree of soiling, being 5 to 10 years for areas with average pollution, and around two years for areas where pollution is high.

C. Cleaning paint residues or graffiti

Façades are subject to vandal attacks with paint stains or graffiti. Since PORCELANOSA Group's STON-KER slabs are characterized by their zero absorption (less than 0.5%), dirt does not penetrate, it only remains on the slab surface.

Use acetone, or alcohol as cleaning product and apply with an absorbent cloth or nonabrasive white fiber scourer.

D. Cleaning rust stains

Rust stains can accumulate naturally on the façade slabs. Clean with water and mild soap with an absorbent cloth or nonabrasive white fiber scourer.

E. Removal of dirt from rainwater

The ventilated façade characteristics limit the dirt deposited from rain water. In the case of rains that drag contaminants present in the air or leachate from the building itself, dirt may accumulate in some specific points of the façade such as window sills, crowning trims, and corners.

Clean with pressurized water and dry with a clean cloth.

F. Cleaning the air chamber

The air chamber existing between the ventilated façade and the substrate is essential for the improvement of the building's thermal conditioning. In order to make air convection easier inside and avoid the formation of thermal bridges, it shall be checked regularly to make sure there are no elements inside.

Remove any dirt build-up inside the chamber with pressured air or water.

This process is especially important in areas where there is a risk of insects, such as wasps or bees, birds, and small mammals nesting inside it. In these cases, it is highly recommended to include anti-fauna barriers and meshes at the façade bottom.

VI. PANEL REPLACEMENT

Should Porcelanosa porcelain panels break during the installation process or beyond, they can be replaced in an isolated manner without having to remove the entire row or wall.

Please contact Porcelanosa Facade Technical Department for assistance and BEFORE removing any panels from your project.

Damage to the façade

Porcelanosa Porcelain Facades are designed to stand the movements and strains expected specifically for each project, and thus it does not require any specific maintenance. However, in the case of:

- Cracks, fissures, or breakage of ceramic pieces.
- Loss of verticality or displacement of pieces with respect to their position on the façade.
- Damage, loss of verticality, or detachments of structure elements of the façade.
- Damage, loss of verticality, or detachments of dressing elements, crowning pieces, or trims of the ventilated façade.
- Water leaks through joints between the ventilated façade and other elements of the façade.

Please contact the Porcelanosa Porcelain Facade Technical Department.

Do not manipulate the façade structure or slabs without technical supervision from the Technical Department

Job Site Recommendations for Damage Prevention

Do not rest any element or structure not included in the project on the façade.

- Do not manipulate the façade structure or slabs without technical supervision from the Technical Department
- Before doing any drilling or machining, check with the ceramic manufacturer.

VII. CONTACT INFO, SCHEDULE AUDITS, ETC.

Porcelanosa Porcelain Facade technical department is available to answer your technical questions.

Please contact us for questions regarding estimation, installation, to request a training or in general regarding the product.

To contact the Porcelanosa Facade Technical Department please call: 201.995.1310 x2017

PORCELANOSA® FACADES



ESR-3343



FL-21906

WWW.PORCELANOSAFACADES.COM